

SSDI65

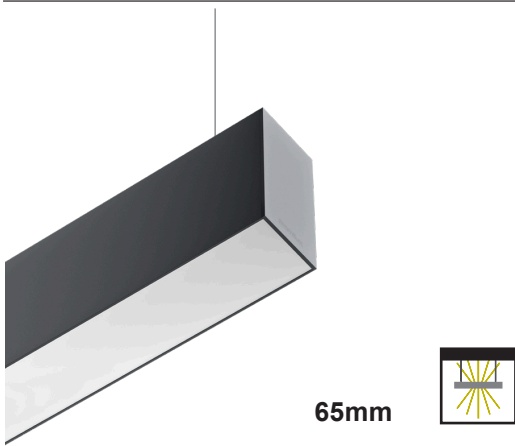

65mm



DESSIN TECHNIQUE .

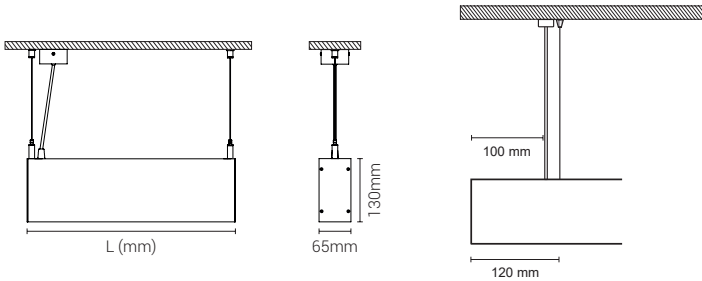

Luminaire suspendu pour application intérieur, avec projection de lumière vers le bas et vers le haut. Corps en aluminium extrudé avec possibilité de peinture en différentes couleurs. Driver intégré dans le profil. Fleuron standard rond en saillie (autres options disponibles). Diffuseur microprismatique en standard, opale ou noir en option

NORMES .

Normes: EN 60598-1:2015, EN 60598-2-1:2012, IEC 60529, EN 50581:2012, IEC 61000-3-2:2014, EN 61547:2009

Directives: 2012/19/UE DEEE, 2014/30/UE Compatibilité électromagnétique 2014/35/UE Basse tension

SYSTEME ÉLECTRIQUE .



SOURCE D'ALIMENTATION .

DRIVER INTEGRE 220-240VAC · 50/60Hz

INFORMATIONS LED .

LED 2700K | 3000K | 4000K | 5000 | 6500K
MacAdam 3 · 50.000 h · L90B50 · Ta -20°C a 45°C · CRI 90 · Dimmable · $\angle 100^\circ$

SSDI65 | IP40 | IK05 | LED Module

Code	L (mm)	Flow/Power (approx. 183lm/W)
GG8-65.057.xxL	570	3850 lm
SSDI65.071.xxL	710	4950 lm
SSDI65.085.xxL	850	6050 lm
SSDI65.099.xxL	990	7150 lm
SSDI65.113.xxL	1130	8250 lm
SSDI65.127.xxL	1270	9350 lm
SSDI65.141.xxL	1410	10450 lm
SSDI65.155.xxL	1550	11550 lm
SSDI65.169.xxL	1690	12650 lm
SSDI65.183.xxL	1830	13750 lm
SSDI65.197.xxL	1970	14850 lm
SSDI65.211.xxL	2110	15950 lm
SSDI65.225.xxL	2250	17050 lm
SSDI65.239.xxL	2390	18150 lm
SSDI65.253.xxL	2530	19250 lm
SSDI65.267.xxL	2670	20350 lm
SSDI65.281.xxL	2810	21450 lm
SSDI65.295.xxL	2950	22550 lm
SSDI65.309.xxL	3090	23650 lm
SSDI65.323.xxL	3230	24750 lm
SSDI65.337.xxL	3370	25850 lm
SSDI65.351.xxL	3510	26950 lm
SSDI65.365.xxL	3650	27500 lm
SSDI65.379.xxL	3790	29150 lm
SSDI65.393.xxL	3930	29700 lm
SSDI65.407.xxL	4070	31350 lm
SSDI65.421.xxL	4210	31900 lm
SSDI65.435.xxL	4350	33550 lm
SSDI65.449.xxL	4490	34100 lm
SSDI65.463.xxL	4630	35750 lm
SSDI65.477.xxL	4770	36300 lm
SSDI65.491.xxL	4910	37400 lm
SSDI65.505.xxL	5050	37950 lm

COULEURS .

- 1 Blanc .
- 2 Gris .
- 3 Gris Satin .
- 4 Brossé .
- 7 Graphite .
- 9 Noir .
- 0 RAL sur demande .

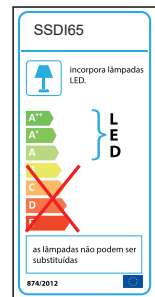

FINITIONS .

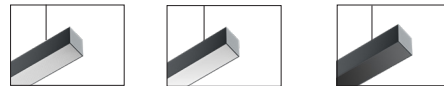

Prismatique UGR<math><19</math>

Opaline

Noir

(Version standard)

PHOTOMÉTRIE .

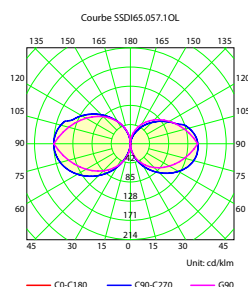

Peut être installé en lignes continues avec la longueur demandée. D'autres mesures disponibles sur demande.

SERVICES ECLAIR

Les professionnels de l'éclairage

FLEURON .

Standard/Inclus



FSR.xXX | Ø58mm
Fleuron Rond Saillant

Version toujours considérée, sauf quand le client indique l'une des options suivantes :



FSQ.xXX | 58x58mm
Fleuron Carré Saillant

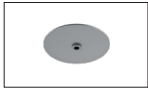

FER.xXX | Ø55mm
Fleuron Rond Encastré



FEQ.xXX | 50x50mm
Fleuron Carré Encastré

CABLE DE SUSPENSION .



CO5.XXX
Standard 1,5m

COx.XXX	
Code	Designation
CO2.XXX	Suspension Cable 2 meters
CO3.XXX	Suspension Cable 3 meters
CO4.XXX	Suspension Cable 4 meters
CO5.XXX	Suspension Cable 5 meters

Autres longueurs disponibles sur demande .

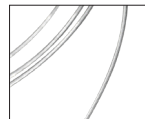

xAx.XXX
Standard 1,5m

xAx.XXX	
Code	Designation
3A2.XXX	Power Cable 3 Conductors 2 Meters
3A3.XXX	Power Cable 3 Conductors 3 Meters
3A4.XXX	Power Cable 3 Conductors 4 Meters
3A5.XXX	Power Cable 3 Conductors 5 Meters
5A2.XXX	Power Cable 5 Conductors 2 Meters
5A3.XXX	Power Cable 5 Conductors 3 Meters
5A4.XXX	Power Cable 5 Conductors 4 Meters
5A5.XXX	Power Cable 5 Conductors 5 Meters

Autres longueurs disponibles sur demande .